



YOUR FIRST STEP TO PERFECT WATER

Premier Water Testing Instruments

2020 CATALOG

HM DIGITAL INC.

1-310-410-3100

HMDigital.com

TDSMeter.com

LOS ANGELES, USA
SEOUL, SOUTH KOREA



ABOUT HM DIGITAL



Global HQ
(Seoul, South Korea)

Since 1987, HM Digital has been the primary source for the finest quality waster testing Instruments.

From our facilities in Los Angeles, Seoul, Qingdao, and New Delhi, we have the capability to ship anywhere in the world and service the entire globe. Our handheld meters, in-line monitors, controllers, sensors and calibrations solutions are used in a myriad of applications. They are superior in quality, features and performance, yet are made available at an economical cost.

HM Digital takes pride not only in the quality of our products, but also in our commitment to customer service and having the shortest lead times in the industry.

With HM Digital instruments, you can find the right solution for your application.

WHY HM DIGITAL?

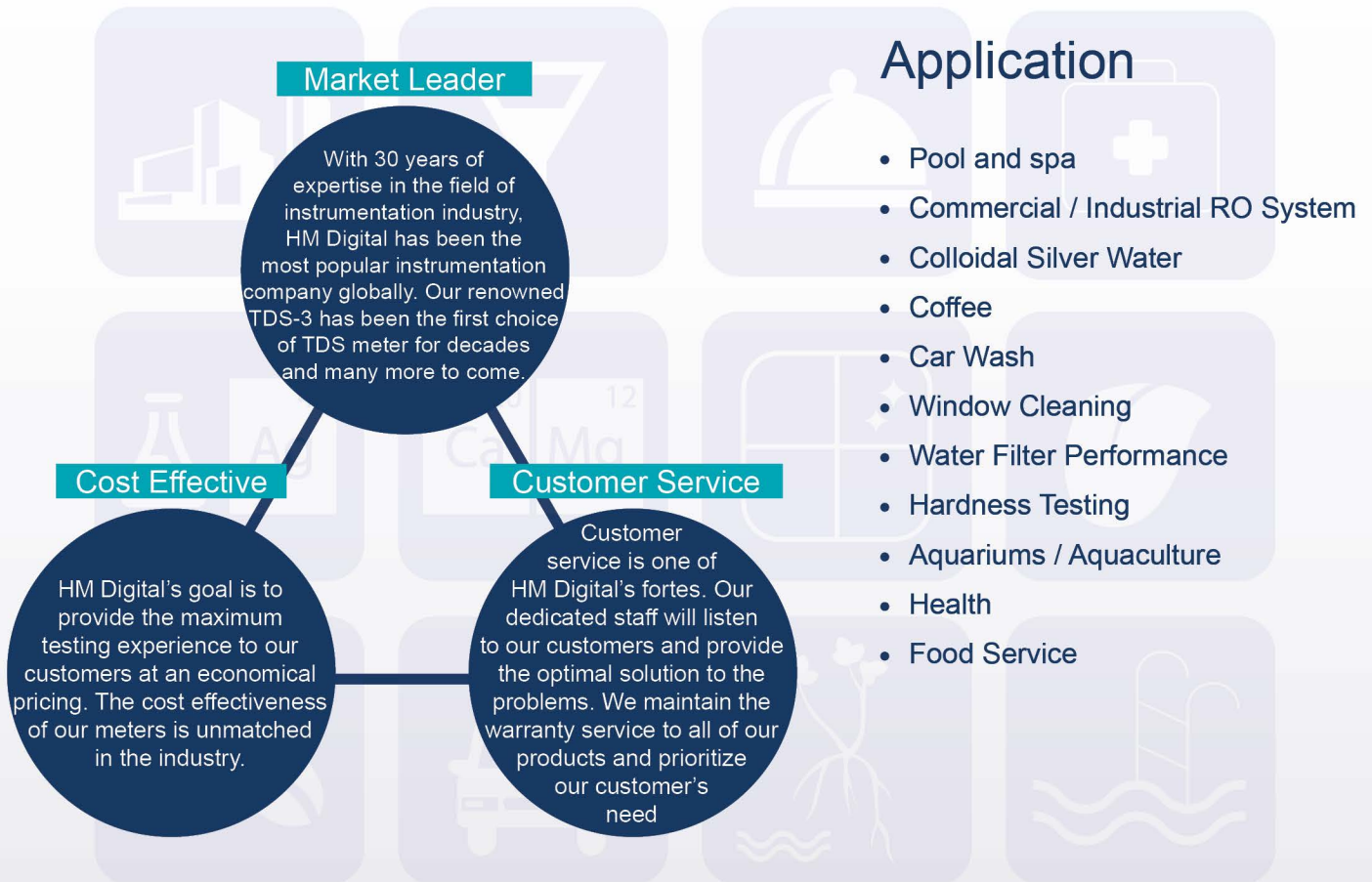

CONTENT

ABOUT HM DIGITAL	1	
SALINITY METER	4	
SB-2000PRO	SAL-1700	SB-1500PRO
SB-500	SB-2600PRO	
REFRACTOMETER	6	
SCM-1000	BTR-1000 (Beer)	RWM-1000
BTR-1000 (Brix)	BTR-1000 (Coffee)	BTR-1000 (Salinity)
BTR-1000 (Wine)		
PRO KITS	8	
HPK-1	HM-200PK	
HANDHELDS	9	
TDS-3	TDS-4TM	COM-80
AP-1	AP-2	PH-80
PRO SERIES HANDHELDS	10	
COM-300	COM-360	COM-100
PH-200	ORP-200	
HM SERIES MONITORS	12	
HM-501	HM-200	HM-100
MONITORS	15	
DM-1	DM-2	LDM-100R
LSM-100	FLM-3	PM-1/ PM-2
CONTROLLERS	16	
PSC-50/ PSC-54	PSC-60/ PSC-64D	PSC-150
PSC-154	CIC-150-N/ CIC-150-4	CIC-152-N/ CIC-152-4
PS-202	PPH-1000	
SENSORS/ ACCESSORIES	18	
LEAK BLOCK SENSOR (LBS-10)	19	
LBS-10		

Salinity Meters

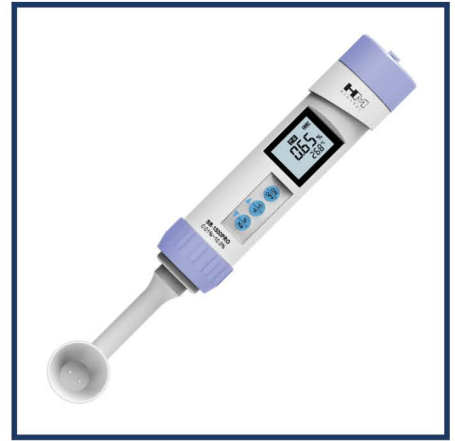

SB-2000PRO

SB-2000PRO is a very convenient salinity meter that automatically turns on by immersing the meter in a solution. With ATC function, SB-2000PRO is always accurate even at high or low temperatures. When the measurement is completed, the meter sends a vibration alert making this product the most user-friendly meter.

RANGE	0.01~10.0%
TEMP	1-99°C / 33-210°F (ATC)
ATC	YES
ACCURACY	± 0.1-0.5%
RESOLUTION	0.01% (0.01%-3.0%) 0.1% (3.0%-10.0%) Temp: 0.1°C/°F
SENSOR	Platinum
CALIBRATION	Factory calibrated
POWER	2 x AAA
DEMENSIONS	17.1 x 2.5 x 2.45 cm (7 x 1 x 1 in)
WEIGHT	66g/2.3oz (W/ BATT)

SB-500

SB-500 can be easily operated without a button, just by a light tap.

RANGE	0.1~ 5.0%
TEMP	1-99°C / 33-210°F (ATC)
ATC	YES
ACCURACY	0.1% ~ 2.0%: ± 0.1% 2.1% ~ 3.0%: ± 0.2% 3.1% ~ 5.0%: ± 0.3%
RESOLUTION	0.1%
SENSOR	Platinum
CALIBRATION	Factory calibrated
POWER	1 x 3V (CR2032)
DEMENSIONS	16.8 x 3.2 x 1.8 cm (6.6 x 1.3 x 0.4 in)
WEIGHT	66g/1.5oz (W/ BATT)

SB-1500PRO

Spoon-type salinity meter that can be used in various fields such as industrial, commercial, and at home. This meter can also read the sodium content in food, which is expressed in milligrams.

RANGE	0.01%~10.0%
TEMP	1-99°C / 33-210°F (ATC)
ATC	YES
ACCURACY	0 ~ 2%: ±0.1% 2 ~ 3%: ±0.2% 3 ~ 4%: ±0.3% 4 ~ 5%: ±0.4% 5 ~ 8%: ±0.5% 8 ~ 10%: ±0.6% Temp: ±1°C/ ±1.8°F
RESOLUTION	0.01% (0.01%-3.0%) 0.1% (3.0%-10.0%) Temp: 0.1°C/°F
SENSOR	Platinum
CALIBRATION	Digital
POWER	2 x AAA
DEMENSIONS	21.6 x 3.4 x 3.4 cm (8 x 1 x 1 in)
WEIGHT	100g/3.5oz (W/ BATT)

Salinity Meters



SAL-1700

Suitable for measuring the salinity in aquariums/ fishery. The salt level is measured in three selectable units (PSU, S.G., and ppt). Each unit has an automatic temperature compensation (ATC) to provide accurate measurements.

RANGE	PSU: 0.0-55.0 SG: 1.000 ~ 1.042 ppt: 0.0 ~ 105.0
TEMP	1-99°C / 33-210°F (ATC)
ATC	YES
ACCURACY	PSU: ± 2.0 SG: ± 0.002 ppt: ± 2.0(0.0~55.1) / ±5.0(55.1~100.0) Temp: ±1°C/ ±1.8°F
RESOLUTION	PSU: 0.1 SG: 0.001 ppt: 0.1 Temp: 0.1°C/°F
SENSOR	Platinum
CALIBRATION	Digital
POWER	2 x AAA
DEMENSIONS	21.6 x 3.4 x 3.4 cm (8 x 1 x 1 in)
WEIGHT	100g/3.5oz (W/ BATT)



SB-2600PRO

Spoon-type salinity meter that can be used in various fields such as industrial, commercial, and home. This meter can also read the sodium content in food, which is expressed in milligrams.

RANGE	0.01%~26.0%
TEMP	1-99°C / 33-210°F (ATC)
ATC	YES
ACCURACY	~2% ±0.1% ~5% ±0.2% 5%~ ±0.3% Temp: ±1°C/ ± 1.8°F
RESOLUTION	0.01% (0.01%-3.0%) 0.1% (3.0%-10.4%) Temp: 0.1°C/°F
SENSOR	Platinum
CALIBRATION	Digital
POWER	2 x AAA
DEMENSIONS	21.6 x 3.4 x 3.4 cm (8 x 1 x 1 in)
WEIGHT	100g/3.5oz (W/ BATT)

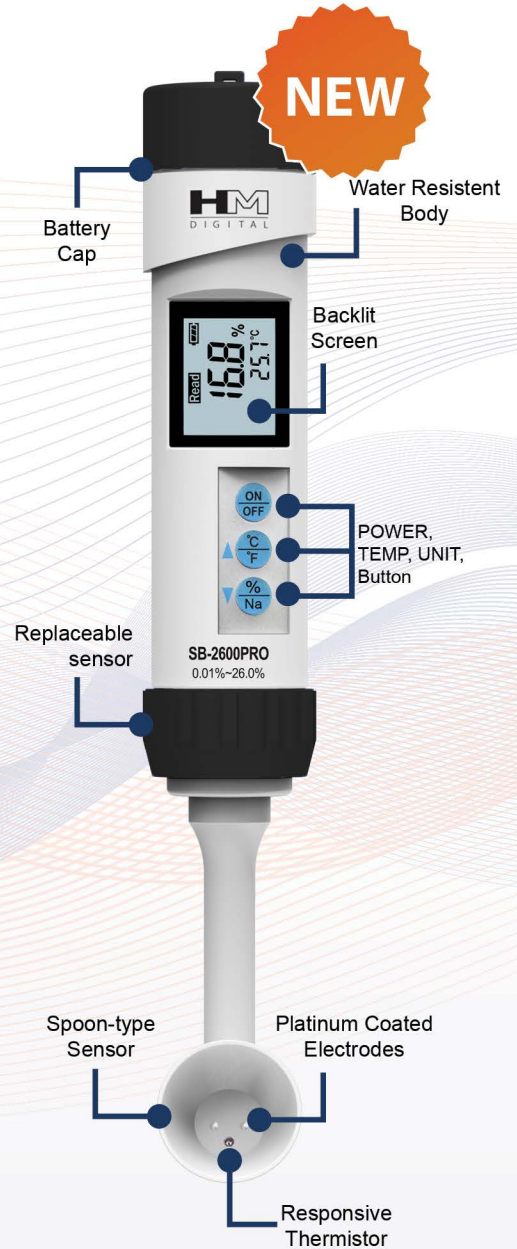

Refractometer

HM DIGITAL refractometers combine advanced measurement technology with easy control. Their reliability to produce accurate readings, suitability in the food service industry, simplicity, and their elegant design attracts “much” attention.

COMMON SPECIFICATION

SENSOR	Glass Prism
ATC	YES (10~60°C)
CALIBRATION	Digital
DEMENSIONS	58 x 36 x 122 mm (2.3 x 1.4 x 4.8 in)
HOUSING	Water-resistant
POWER	2 x AAA
WEIGHT	149g/5.3oz (w/ cover & battery)



Superior Accuracy



Backlit Display



Removable Silicone Case



SCM-1000

RANGE	Brix: 0.0~55.0% Temp: 1-80°C / 33-176°F
RESOLUTION	Brix: 0.1% Temp: 0.1°C
ACCURACY	Brix: ±0.2% Temp: ±1.0°C

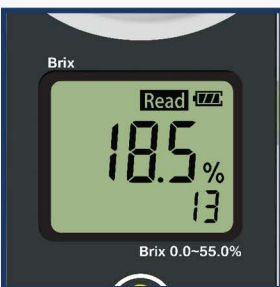

Large LCD Display



Bluetooth Connection
(For some models)



Fast to Read

Refractometer



BTR-1000 (Brix)

RANGE	Brix: 0.0~55.0% Temp: 0-70°C / 32-158°F
RESOLUTION	Brix: 0.1% Temp: 0.1°C
ACCURACY	Brix: ±0.2% Temp: ±1.0°C
CONNECTION	Bluetooth



BTR-1000 (Salinity)

RANGE	Salinity(%): 0.0~28.0% Temp: 0-70°C / 32-158°F
RESOLUTION	Salinity: 0.1% Temp: 0.1°C
ACCURACY	Salinity: ±0.1% Temp: ±1.0°C
CONNECTION	Bluetooth



BTR-1000 (Beer)

RANGE	Brix: 0.0~30.0% Plato: 0.0~30.0°P SG: 1.000~1.129 / Temp: 0-70°C / 32-158°F
RESOLUTION	Brix/Plato: 0.1% SG: 0.001 Temp: 0.1°C
ACCURACY	Brix/Plato: ±0.2% SG: ±0.002 Temp: ±1.0°C
CONNECTION	Bluetooth



BTR-1000 (Coffee)

RANGE	Brix: 0.00~26.00% TDS: 0.00~23.00% Temp: 0-70°C / 32-158°F
RESOLUTION	Brix: 0.01% TDS: 0.01% Temp: 0.1°C
ACCURACY	Brix: ±0.2% TDS: ±0.2% Temp: ±1.0°C



BTR-1000 (Wine)

RANGE	Brix: 0.0~55.0% KMW: 0.0~46.4° Be: 0.0~29.8° Babo: 0.0~46.4° Oe: 3~256° TAVP: 0.0~37.9% Temp: 0~70°C (32~158°F)
RESOLUTION	0.1 (1.0 for Oe) Temp: 0.1°C
ACCURACY	Brix: ±0.2% Temp: ±1.0°C
CONNECTION	Bluetooth



RWM-1000 (Wine Refractometer)

RANGE	Brix: 0.0~55.0% KMW: 0.0~46.4° Be: 0.0~29.8° Babo: 0.0~46.4° Oe: 3~256° TAVP: 0.0~37.9% Temp: 0~70°C (32~158°F)
RESOLUTION	0.1 (1.0 for Oe) Temp: 0.1°C
ACCURACY	Brix: ±0.2% Temp: ±1.0°C

* Not Available in the US/ North America

NEW

HYDROPONICS PRO KIT



- 1x PH-200 Meter
- 1x COM-100 Meter
- 3x PH-4 Buffer
- 3x PH-7 Buffer
- 3x CP-1000 Solution
- 3x PH-STOR Solution
- 2x Lanyard
- 3x Solution Cup

The HPK-1 is the hydro growers all in one solution. This kit combines the accurate COM-100 TDS (PPM)/EC/Temp meter and the reliable PH-200 pH/Temp meters together into one package. It also includes a zip closure protective case and a generous amount of calibration and storage solutions.

NEW

HM-200 PRO KIT



- 1x HM-200 Meter
- 1x SP-C2 TDS/EC Probe
- 1x SP-P5 pH Probe
- 3x PH-4 Buffer
- 3x PH-7 Buffer
- 3x CP-1000 Solution
- 3x PH-STOR Solution
- 3x Solution Cup

The HM-200 Pro Kit comes with a portable, durable, water resistant zipper bag. The bag allows for an easy and safe measuring environment with enough space to store necessary accessories.

Handhelds



TDS-3

RANGE	0-9990 ppm Temp: 1-80°C / 33-176°F
ATC	YES
ACCURACY	± 2%
RESOLUTION	1ppm
CALIBRATION	Screw type
POWER	2 x LR44
SIZE	15.5 x 3.1 x 2.3 cm (6.1 x 1.25 x 1.0 in)
WEIGHT	76.5 g/2.7oz (w/ case)



AP-1

RANGE	0-5000ppm Temp: 1-80°C / 33-176°F
ATC	YES
ACCURACY	± 2%
RESOLUTION	1ppm
CALIBRATION	Digital
POWER	1 x CR2032
SIZE	15 x 2.8 x 1.3 cm (5.9 x 1.1 x 0.5 in)
WEIGHT	42.5g/1.5oz



AP-2

RANGE	0-9990µS Temp: 1-80°C / 33-176°F
ATC	YES
ACCURACY	± 2%
RESOLUTION	1µS
CALIBRATION	Digital
POWER	1 x CR2032
SIZE	15 x 2.8 x 1.3 cm (5.9 x 1.1 x 0.5 in)
WEIGHT	42.5g/1.5oz



TDS-4TM

RANGE	0-9990 ppm Temp: 1-80°C / 33-176°F
ATC	YES
ACCURACY	± 2%
RESOLUTION	1ppm
CALIBRATION	Screw type
POWER	2 x LR44
SIZE	14 x 2.3 x 1.5 cm (5.5 x 0.9 x 5.9 in)
WEIGHT	34.0g/1.9oz



COM-80

RANGE	0-9999µS / 0-9.9mS Temp: 1-80°C / 33-176°F
ATC	YES
ACCURACY	± 2%
RESOLUTION	1µS; 0.1mS 1ppm; 0.1°C/F
CALIBRATION	Digital
POWER	3 x LR44
SIZE	15.3 x 3.2 x 1.8 cm (6.0 x 1.3 x 0.7 in)
WEIGHT	53.9g/1.9oz



PH-80

RANGE	0.0 - 14.0 pH Temp: 1-80°C / 33-176°F
ATC	YES
ACCURACY	± 0.1pH
RESOLUTION	0.1 pH; 0.1°C/F
CALIBRATION	Auto at 4, 7, 10 pH
POWER	3 x LR44
SIZE	15.3 x 3.2 x 1.8 cm (6.0 x 1.3 x 0.7 in)
WEIGHT	53.9g/1.9oz

PRO SERIES HANDHELDS

AAA batteries
and water
resistant
housing



Replaceable
sensors



Easy and
quick
calibration



HOT!



The Pro series are Professional handheld instruments that may be used in all field applications. they are not only fast and accurate, but they are also waterproof, simple to calibrate, and have replaceable sensors. The portable measuring instruments of HM Digital are trusted in the market and are known for their ease of use.

COM-360

RANGE	pH : 0.0-14.0 pH EC: 0-9990 μ S 0-9.99 mS TDS: 0-8560ppm 0.5 (NaCl) 0-5000 ppm 0.7 (442)
TEMP RANGE	0.1-50°C 32-122°
ATC	YES
ACCURACY	pH: \pm 0.1 EC/TDS: \pm 2% Temp: \pm 1°C/ \pm 1.8°F
RESOLUTION	pH: 0.1pH EC: 1 μ S (0-999) 10 μ S (1000-9990) 0.01mS (0-9.99) TDS: 0.1 ppm (0-99) 1ppm (100-999) 10ppm (1000-9990) Temp: 0.1°C/°F
CALIBRATION	pH: Automatic in pH4,7, or 10 buffer EC&TDS: Digital push button
POWER	2 x AAA
SIZE	20 x 3.4 x 3.4 cm (7.8 x 1.3 x 1.3 in)
WEIGHT	130g/4.6oz

COM-300

RANGE	pH : 0.0-14.0 pH EC: 0-9990 μ S 0-9.99 mS TDS: 0-8560ppm 0.5 (NaCl) 0-5000 ppm 0.7 (442)
TEMP RANGE	0.1-50°C 32-122°F
ATC	YES
ACCURACY	pH: \pm 0.1 EC/TDS: \pm 2% Temp: \pm 1°C/ \pm 1.8°F
RESOLUTION	pH: 0.1pH EC: 1 μ S (0-999) 10 μ S (1000-9990) 0.01mS (0-9.99) TDS: 0.1 ppm (0-99) 1ppm (100-999) 10ppm (1000-9990) Temp: 0.1°C/°F
CALIBRATION	pH: Automatic in pH4,7, or 10 buffer EC&TDS: Digital push button
POWER	2 x AAA
SIZE	18.5 x 3.4 x 3.4 cm (7.3 x 1.3 x 1.3 in)
WEIGHT	127g/4.5oz

PRO SERIES HANDHELDS



COM-100

RANGE	EC: 0-9990 μ S 0-9.99 mS TDS: 0-8560ppm 0.5 (NaCl) scale 0-5000 ppm 0.7 (442) 0-8.56 ppt: 0.7 (442) 0-500 ppt; (NaCl)
TEMP RANGE	0.1-55°C 32-130°F
ATC	YES
ACCURACY	\pm 2%
RESOLUTION	EC: 0.1 μ S (0-99) 1 μ S (100-999) 10 μ S (1000-9990) 0.01mS (0-9.99) TDS: 0.1 ppm (0-99) 1ppm (100-999) 10ppm (1000-9990) 0.01 ppt (0-8.56) Temp: 0.1°C/°F
CALIBRATION	Digital push button
POWER	2 x AAA
SIZE	18.5 x 3.4 x 3.4 cm (7.3 x 1.3 x 1.3 in)
WEIGHT	127g/4.5oz



PH-200

RANGE	pH: 0.0-14.0 pH
TEMP RANGE	0.1-55°C 32-130°F
ATC	YES
ACCURACY	\pm 0.1pH
RESOLUTION	pH : 0.01 pH Temp: 0.1°C/°F
CALIBRATION	Automatic in pH4,7, or 10 buffer
POWER	2 x AAA
SIZE	18.5 x 3.4 x 3.4 cm (7.3 x 1.3 x 1.3 in)
WEIGHT	127g/4.5oz



ORP-200

RANGE	ORP: -999 to +1000mV
TEMP RANGE	1-80°C 33-176°F
ATC	NO
ACCURACY	\pm 0.5% (\pm 2mV)
RESOLUTION	ORP: 1mV Temp: 0.1°C/°F
CALIBRATION	Digital push button
POWER	2 x AAA
SIZE	18.5 x 3.4 x 3.4 cm (7.3 x 1.3 x 1.3 in)
WEIGHT	127g/4.5oz



HM-500

RANGE	pH: 0.0~14.0pH
	EC: 0~9990 μ S/0~20mS
	TDS: 0~9990ppm/ 0~10ppt
	Temp: 0~55°C/ 32~130°F
RESOLUTION	pH: 0.1pH
	EC: 0.1 μ S (0~99.9) 1 μ S (100~999) 10 μ S (1000~9990) 0.01mS (0.01~20.00)
	TDS: 0.1ppm (0~99.9) 1ppm (100~999) 10ppm (1000~9990) 0.01 ppt (0.01~10.00)
	Temp: 0.1°C/°F
ACCURACY	pH: \pm 0.1pH
	EC: \pm 2%
	TDS: \pm 2%
	Temp: \pm 1°C / \pm 1.8°F
CALIBRATION	Digital
POWER	Rechargeable Li-ion Battery
SIZE	20 x 11 x 3.6 cm
	(8 x 4 x 1.4 in)
WEIGHT	430g/15.1oz



Wall-mount

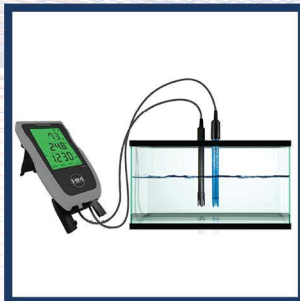

Bench-top mode



Auto brightness

FEATURES

- Continuous pH (pe) / EC (conductivity) / TDS / temperature monitoring
- Rechargeable battery
- Various usage: Portable / Wall-mount / Bench-top
- Save function: save 20 measurements
- Auto OFF function: 5 minutes
- Alarm: High & Low set value (ON / OFF possible)
- Screen: LCD touch screen (automatic backlight function)
- Sensor: Platinum EC / TDS Sensor, Single Junction pH sensor



HM-200

RANGE	pH: 0.0~14.0pH
	EC: 0~9990µS/0~20mS
	TDS: 0~9990ppm
	Temp: 0.0~55°C/ 32~130°F
RESOLUTION	pH: 0.1pH
	EC:
	0.1µS (0~99.9)
	1µS (100~999)
	10µS (1000~9990)
0.01mS (0.01~20.00)	
TDS:	0.1ppm (0~99.9)
	1ppm (100~999)
	10ppm (1000~9990)
	Temp: 0.1°C/°F
ACCURACY	pH: ± 0.1pH
	EC: ± 2%
	TDS: ± 2%
	Temp: ±1°C / ±1.8°F
CALIBRATION	Digital
POWER	2 x AA
SIZE	14 x 6.6 x 2.8 cm
	(5.5 x 2.6 x 1.1 in)
WEIGHT	198g/7.0oz



Removable cover



Portable



Backlit

FEATURES

- pH / EC / TDS / temperature measurement
- 5 units: pH, µS, mS, ppm 0.5 (NaCl) Scale & 0.7 (442™) Scale
- Automatic Temperature Compensation Function (ATC)
- Digital calibration
- Large readability LCD screen
- Simultaneous display of three measured values of pH / EC or TDS / temperature
- Replaceable sensors
- Included Accessories: Protective cover, 2 AA batteries, pH 4 & 7 calibration solution, pH preservation solution

HM-100 Combo Meter



HM-100

RANGE	pH: 0.0~14.0pH EC: 0-10mS TDS: 0~9990 ppm Temp: 0.0~55°C / 32~130°F
RESOLUTION	pH: 0.01pH EC: 0.01mS (0.01~10.00) TDS: 1ppm (0~999) 10ppm (1000~9990) Temp: 0.1°C/°F
ACCURACY	pH: ± 0.1 pH EC: $\pm 2\%$ TDS: $\pm 2\%$ Temp: $\pm 1^\circ\text{C}$ / $\pm 1.8^\circ\text{F}$
CALIBRATION	Digital
POWER	DC power adapter (5V /1A)
SIZE	20 x 11 x 3.3 cm (8 x 4 x 1.4 in)
WEIGHT	285g/10.1oz



Large Screen,
Simple control



Wall-mount



Plug type sensor

FEATURES

- pH / EC / TDS / temperature measurement
- Various units: pH, mS, ppm, 0.5 (NaCl) & 0.7 (442™)
- Automatic Temperature Compensation Function (ATC)
- Digital calibration method
- Displays pH / EC or TDS / temperature simultaneously.
- Replaceable sensors

Monitor

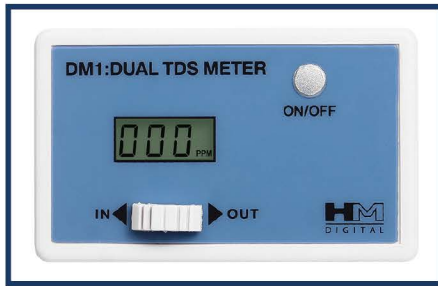

DM-1 Dual TDS Monitor

RANGE	TDS: 0-9990 ppm
ACCURACY	± 2%
RESOLUTION	1ppm(0-999) 10ppm(1000-9990)
ATC	YES (1-65°C/33-149°F)
CALIBRATION	Analog
SENSOR	1/4" quick connect (2EA)
SENSOR CABLE	62.2cm /2.0ft
POWER	2 x LR44
SIZE	7.6 x 2 x 4.7 cm (3 x 0.8 x 1.9 in)
WEIGHT	79.4g/2.8oz



LSM-100 Monitor

RANGE	TDS: 0-9999 ppm 0-10.0 ppt EC: 0-9999 µS 0-20.00 mS
ACCURACY	± 2%
RESOLUTION	0.1 (0-99) 1 (100-9999) 0.01 (ms/ppt)
ATC	YES (1-65°C/33-149°F)
CALIBRATION	Digital
SENSOR	1/2" NPT threaded
SENSOR CABLE	3m/9.8ft
POWER	2 x AA
SIZE	7.6 x 2 x 4.7 cm (3 x 0.8 x 1.9 in)
WEIGHT	198g/7.0oz



LDM-100R Dual Rejection Monitor

RANGE	TDS: 0-9999 ppm 0-10.0 ppt EC: 0-9999 µS 0-20.00 mS
ACCURACY	± 2%
RESOLUTION	0.1 (0-99) 1 (100-9999) 0.01 (ms/ppt)
ATC	YES (1-65°C/33-149°F)
CALIBRATION	Digital
SENSOR	1/2" NPT threaded
SENSOR CABLE	3m/9.8ft
POWER	2 x AA
SIZE	7.6 x 2 x 4.7 cm (3 x 0.8 x 1.9 in)
WEIGHT	198g/7.0oz

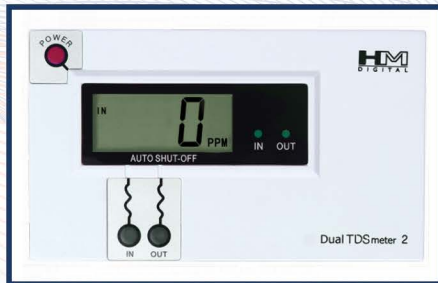

DM-2/ DM-2EC Dual TDS Monitor

RANGE	TDS: 0-9990 ppm EC: 0-9990 µS
ACCURACY	± 2%
RESOLUTION	1 (0-999) 10 (1000-9990)
ATC	YES (1-65°C/33-149°F)
CALIBRATION	Analog
SENSOR	1/4" quick connect (2EA)
SENSOR CABLE	116.8cm/3.8ft shielded
POWER	2 x AA
SIZE	11.6 x 6.8 x 1.8 cm (4.6 x 2.6 x 0.7 in)
WEIGHT	201.3g/7.1oz



FLM-3 Flow Meter

RANGE	0.8-8.0 LPM 0.2-2.1 GPM 0-99999 gallon/liter
ACCURACY	± 10%
RESOLUTION	0.1 LPM/GPM; 1 gallon/liter
SET POINT	Programmable
ALARM	Sound
SENSOR	1/4" quick connect
POWER	2 x AA
SIZE	6.6 x 9.0 x 6.3 cm (2.6 x 3.5 x 2.5 in)
WEIGHT	207g/7.3oz



PM-1/ PM-2

RANGE	TDS: 0-200 ppm
ACCURACY	± 2%
ATC	YES (1-65°C/33-149°F)
CALIBRATION	Factory calibrated
SET POINT	Set by dip switch
ALARM	Light and Sound
SENSOR	1/4" quick connect
SENSOR CABLE	62.2cm /2.0ft
POWER	AC 110V / 220V
SIZE	9.1 x 7.1 x 4 cm (3.6 x 2.8 x 1.6 in)
WEIGHT	275g/9.7oz

Controller

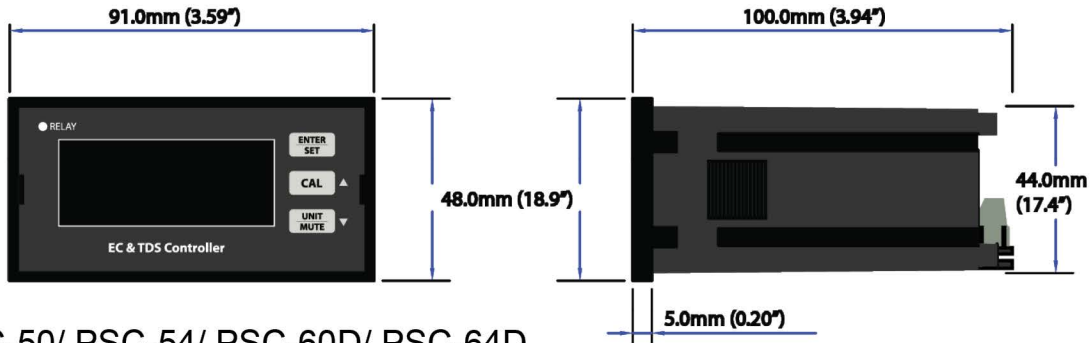

FOR: PSC-50/ PSC-54/ PSC-60D/ PSC-64D

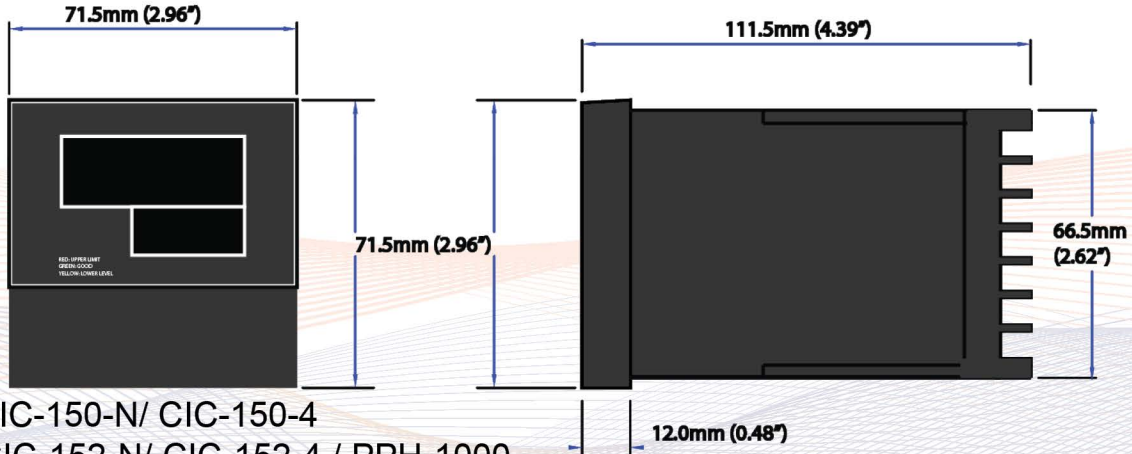

FOR : CIC-150-N/ CIC-150-4
CIC-152-N/ CIC-152-4 / PPH-1000
PSC-150/ PSC-154

HM digital controllers are suitable for industrial professionals such as boilers and cooling towers, industrial strength RO or DI water purification, car wash and window cleaning.



PSC-50 / PSC-54

RANGE	TDS: 0-9999 ppm 0-10 ppt EC: 0-9999 µS 0-20mS
ACCURACY	± 2%
RESOLUTION	0.1 (0-99.9) 1 (100-9999) 0.01 (mS/ ppt)
ATC	YES (1-65°C/33-149°F)
CALIBRATION	Digital
OUTPUT SINGAL	4-20mA (PSC-54 ONLY)
SENSOR	1/2" NPTF, 3m shielded
POWER	AC 110V / 220V
SIZE	9.6 x 4.8 x 10 cm (3.8 x 1.9 x 3.9 in)



PSC-60D / PSC-64D

RANGE	TDS: 0-9999 ppm 0-10 ppt EC: 0-9999 µS 0-20mS
ACCURACY	± 2%
RESOLUTION	0.1 (0-99.9) 1 (100-9999) 0.01 (mS/ ppt)
ATC	YES (1-65°C/33-149°F)
CALIBRATION	Digital
OUTPUT SINGAL	4-20mA (PSC-64 ONLY)
SENSOR	1/2" NPTF, 3m shielded
POWER	AC 110V / 220V
SIZE	9.6 x 4.8 x 10 cm (3.8 x 1.9 x 3.9 in)

Controller



PSC-150

RANGE	0-9999 ppm 0-9999 µS
ACCURACY	± 2%
RESOLUTION	0.1(0-999 ppm/µS) 1(1000-9999 ppm/µS)
ATC	YES (1-65°C/33-149°F)
CALIBRATION	Digital
RELAY	Simple Switch, Programmable
ALARM	Programmable
SENSOR	1/2" NPTF, 3m shielded
POWER	AC 110V / 220V
SIZE	7.2 x 7.2 x 10.2 cm (2.8 x 2.8 x 4.0 in)



PSC-154

RANGE	0-9999 ppm 0-9999 µS
ACCURACY	± 2%
RESOLUTION	0.1(0-999ppm/µS) 1(1000-9999 ppm/µS)
ATC	YES (1-65°C/33-149°F)
CALIBRATION	Digital
OUTPUT SINGAL	4-20mA (PSC-154 ONLY)
RELAY	Simple Switch, Programmable
ALARM	Programmable
SENSOR	1/2" NPTF, 3m shielded
POWER	AC 110V / 220V
SIZE	7.2 x 7.2 x 10.2 cm (2.8 x 2.8 x 4.0 in)



CIC-150-N / CIC-150-4

RANGE	0-5000 ppm NaCl 0-8500 ppm 442 0-9999 µS
ACCURACY	± 2%
RESOLUTION	0.1(0-999ppm/µS) 1(1000-8500ppm/µS)
ATC	YES (1-65°C/33-149°F)
CALIBRATION	Digital
RELAY	Two, upper and lower limit
ALARM	Two independent alarms (max. and min)
SENSOR	1/2" NPTF, 3m shielded
POWER	AC 110V / 220V
SIZE	7.2 x 7.2 x 10.2 cm (2.8 x 2.8 x 4.0 in)



CIC-152-N / CIC-152-4

RANGE	0-5000 ppm NaCl 0-8500 ppm 442 0-9999 µS
ACCURACY	± 2%
RESOLUTION	0.1(0-999ppm/µS) 1(1000-8500ppm/µS)
ATC	YES (1-65°C/33-149°F)
CALIBRATION	Digital
RELAY	Two, upper and lower limit
ALARM	Two independent alarms (max. and min)
SENSOR	1/2" NPTF, 3m shielded
POWER	AC 110V / 220V
SIZE	7.2 x 7.2 x 10.2 cm (2.8 x 2.8 x 4.0 in)



PS-202

RANGE	0-999 ppm (mg/L)
ACCURACY	± 2%
RESOLUTION	1 ppm
ATC	YES (1-65°C/33-149°F)
CALIBRATION	Analog
RELAY	Simple Switch, Programmable
ALARM	Programmable
SENSOR	1/2" NPTF, 3m shielded
POWER	AC 110V / 220V
SIZE	9.4 x 9.4 x 12.5 cm (3.7 x 3.7 x 4.5 in)



PPH-1000

RANGE	0.01 – 14.00 pH
ACCURACY	±0.1pH
RESOLUTION	0.01 pH / 0.1°C (0.1°F)
ATC	YES (1-65°C/33-149°F)
CALIBRATION	Digital
RELAY	Two, upper and lower limit
ALARM	Programmable
SENSOR	3/4" Electrode 3m shielded
POWER	AC 110V / 220V
SIZE	7.2 x 7.2 x 11.1 cm (2.8 x 2.8 x 4.4 in)

SENSORS/ ACCESSORIES



SP-1/ SP-1-PSC
 - High quality construction
 -Stainless steel sensor pins
 -1/2" Thread (NPT)
 -4-pin BNC
 -Thermometer included
 -Pressure tested



SP-O2
 ORP-200 Replacement probe
 -ABS material
 -Thermometer included



SP-P2
 PH-200, COM-360 Replacement probe
 -ABS material
 -Glass pH sensor with reference tube
 -Thermometer included



SP-C1/ SP-C4
 SP-C1= COM-100
 SP-C4=COM-360
 -ABS material
 -Stainless steel sensor pins
 -Thermometer included



SP-C3
 COM-300 Replacement probe
 -ABS material
 -Stainless steel sensor pins
 -Glass pH sensor with reference tube
 -Thermometer included



SP-C2/ SP-C5
 C2: HM-200, HM-100
 C5: HM-501
 - Platinum plated sensor pins
 - Stainless steel sensor pins



SP-P5
 For HM Series
 -Glass pH probe with single junction Ag/AgCl, Sat, KCl gel reference tube



SP-P6
 For HM Series
 -Glass pH probe with single junction Ag/AgCl, Sat, KCl gel reference tube



SP-P7
 For HM Series
 -Glass pH probe with single junction Ag/AgCl, Sat, KCl gel reference tube
 -3/4" Thread



SP-P10
 - Glass pH probe with single junction Ag/AgCl, Sat, KCl gel reference tube
 - 3/4" Thread
 - For industrial uses



SP-G1
 - High quality construction
 - Graphite, Thermometer
 - 3/4" Thread
 - 3m/10 feet shielded cable



PH-P4
 - PH-4 Calibration solution
 - 20 x 20 ml Pack



PH-P7
 - PH-7 Calibration solution
 - 20 x 20 ml Pack



PH-PSTOR
 - PH-STOR Electrode storage solution
 - 20 x 20 ml Pack



PH-STOR
 - PH-STOR Electrode storage solution (60ml)
 - Bottle designed for multiple uses



ASP-20
 - 20 Packs of assorted solutions
 - 5 PH-STOR
 - 5 PH-P4
 - 5 PH-P7
 - 5 CP-1000



CP-1000
 - C-1000 TDS Calibration solution
 - 20 x 20 ml Pack
 - NaCl @ 25°C / 77 °F



ORP-STOR
 - ORP sensor storage solution
 - Bottle designed for multiple uses

LEAK BLOCK SENSOR (LBS-10)

LBS-10

TEMP RANGE	1.1~63°C / 34~145°F
MAX. FLOW RATE	5 GPM / 19 LPM
MAX. PRESSURE	125 psi / 8.6 bar
CONNECTION	3/8" FNPT, 1/2" MBSP
POWER	1 X 9V Battery
WEIGHT	31.2g/1.1oz
CABLE	1M/3.2ft

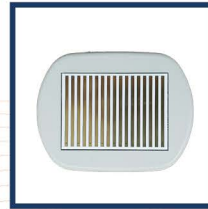

Large and accurate sensor



ID: 3/8" NPT
OD: 1/2" BSP



Available with various fittings

Normal Situation (Standby Mode)

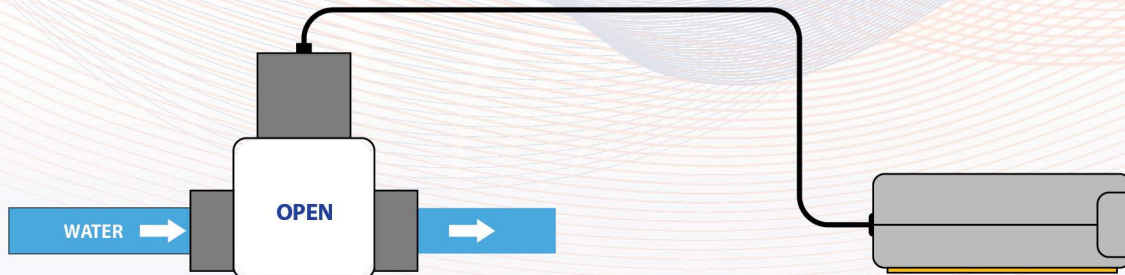

Leakage Situation (Leak Block Mode)

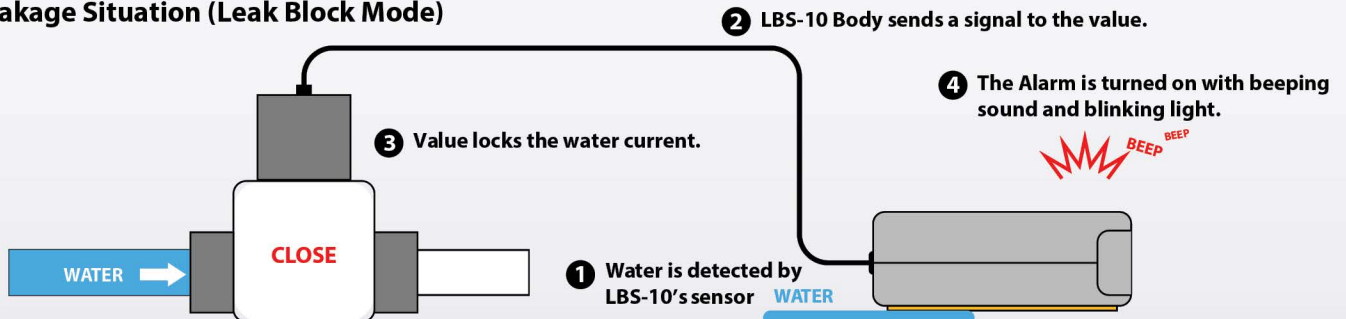

YOUR FIRST STEP TO PERFECT WATER

Premier Water Testing Instruments Since 1987

CATALOG

HM DIGITAL INC.

1-310-410-3100

HMDigital.com

TDSMeter.com

LOS ANGELES, USA

SEOUL, SOUTH KOREA



VER1.6E.US